

CEL-FI GO G41

In-Building Cellular Coverage Solution

KIT#: G41-BE-003

Combining unmatched performance with ease of installation, CEL-FI GO G41 is a single-operator cellular signal booster that delivers reliable in-building 4G and 5G connectivity for “small box” retail stores, branch offices, and homes. In addition to featuring the latest Nextivity proprietary 4th generation IntelliBoost technology, which delivers channelized signal boosting and industry-leading signal gain up to 100 dB, GO G41 can be installed in as little as one day and can be monitored and managed remotely via the Nextivity WAVE Portal. GO G41 also gives you the flexibility to select and switch which MNO signal to boost via the Nextivity WAVE App.



CEL-FI GO G41

Features and benefits include:

- Latest 4th generation Nextivity proprietary IntelliBoost chip delivers channelized coverage for specific mobile network operator’s (MNO) signals
- Ready to extend coverage for future 5G networks
- Industry-leading signal gain up to 100 dB to overcome coverage challenges where no other solution can
- Automatic gain control (AGC) feature automatically adjusts the signal strength to prevent interference with the MNO network
- System monitoring via Nextivity WAVE App and management with WAVE Portal

 Use Nextivity **WAVE** App to view real-time system performance.

Download on the App Store

GET IT ON Google Play

Specifications

Frequency Bands	2/4/5/12/13/25
Relay Channel Bandwidths (MHz)	5/10/15/20
Networks	4G/5G
Network Protocols	LTE/DSS/NR*
Network Selection	Automatically best available (WAVE App for manual setting)
Duplex Modes	FDD
# of Relay Bands (MHz max.)	2
Relay Bandwidth (MHz max.)	20 + 20
Output Downlink Power (All Bands) (dBm max.)	16
Output Uplink Power (Bands 2/4/25) (dBm max.)	22
Output Uplink Power (Bands 5/12/13) (dBm max.)	20
System Gain (dBm max.)	100
Enterprise-Grade Echo Cancellation (dB min.)	30
Return Loss (dB typ.)	-8
Impedance (Ω nom.)	50

*Available with software update in 2024

Bands

Frequency Bands	Downlink (MHz)	Uplink (MHz)	Max. Relay BW (MHz)
2	1930-1990	1850-1910	20
4	2110-2155	1710-1755	20
5	869-894	824-849	15
12	729-746	699-716	10
13	746-756	777-787	10
25	1930-1995	1850-1915	20

Interface

Donor RF Connector	SMA (f)
Server RF Connector	SMA (f)
DC Input	5.5 x 2.5 mm (f) Barrel
Device Setup	Bluetooth for WAVE App
Power & System Status	Bi-color LED (Green/Red)
LAN Status	Bi-color LED (Green/Red)
Factory Debug only	USB 2.0 Micro-B
System Management & SW Updates	WAVE App for iOS 11.0 or later WAVE App for Android WAVE Portal for Desktop

Compliance

3GPP	TS 25.143 Rel 13 3GPP TS 36.143 Rel 13
FCC	Compliant Part 15, Part 20, Part 22, Part 24, Part 27
RoHS3	EN 63000: 2018
UL	Yes
ISED	Yes
Bluetooth	LE Ver 4.2

Power Supply

Power Consumption (W max.)	30
Power Supply Plug	Type A (US)
Power Supply Cable	18 AWG
Power Supply Cable Length (ft (m))	6 (1.85)

Environmental

Operating Temperature (°F (°C))	32 to 104 (0 to 40)
Storage Temperature (°F (°C))	-31 to 158 (-35 to 70)
Heat Dissipation	Passive Convection
Surface Temperature (°F (°C) max. at ambient)	111.2 (44)
Non-condensing Humidity (%)	0 to 95
Ingress Protection Rating	IPX0 Indoor Only

Mechanical

Main Unit Dimensions (in (mm))	10.5 x 4.2 x 2.2 (266.7 x 106.7 x 55.9)
Main Unit Weight (lbs (kg))	2.3 (1.0)

Ordering Information

KIT#	G41-BE-003
Region	AMER
Frequency Bands	2/4/5/12/13/25
Box Contents	Main Unit 1x AC Adapter (290N025-001) 4x Mounting Screws 4x Drywall Anchors Quick Installation Guide
Kit Shipping Dimensions (in (mm))	16.3 x 4.9 x 3.0 (413 x 124 x 76)
Kit Shipping Weight (lbs (kg))	3.3 (1.50)
Harmonized Tariff Schedule (HTS)	8517.18.00.50
Export Control Classification Number (ECCN)	EAR99

CEL-FI GO G41 Main Unit Outline

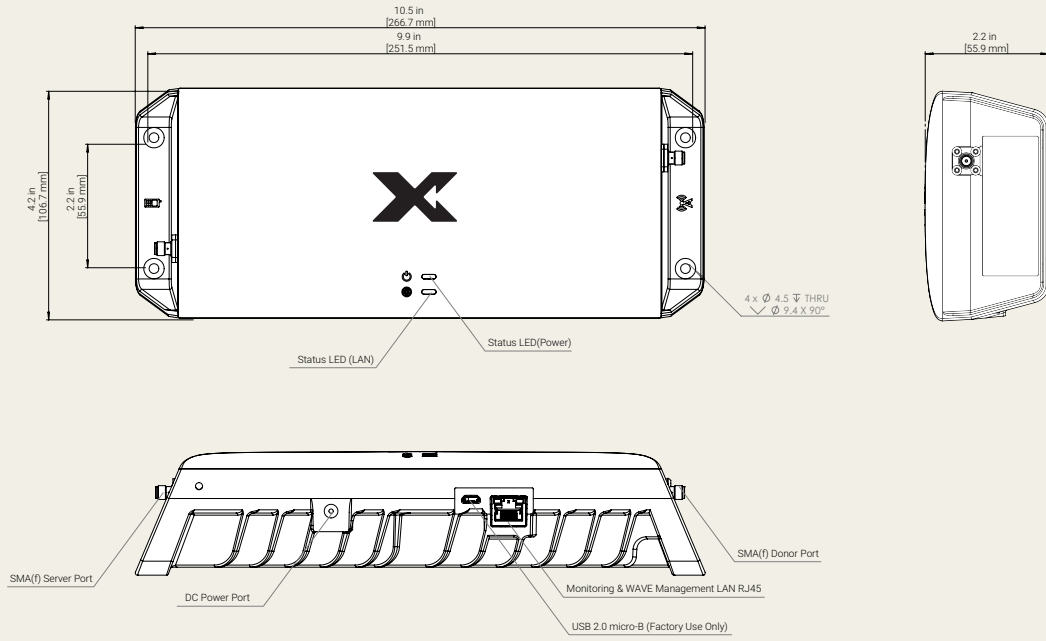

Product specifications are subject to change without prior notification.

Log Periodic Antenna

Directional High-Gain SISO Outdoor Log Periodic Antenna

Designed by WAVEFORM in the USA

SKU: ANT660-NF-LOGP11



600 to 6000 MHz



4G and 5G Support



Up to 9.1 dBi Gain



Outdoor Rated



N-Female Connectors

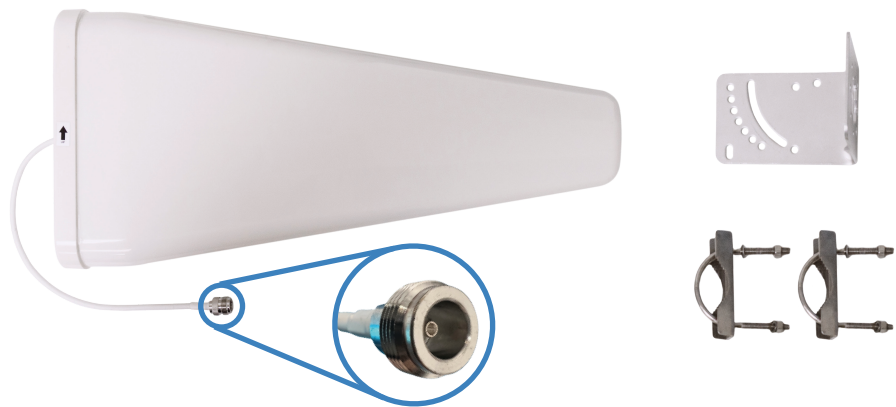

Specifications:

Electrical:

Freq. Range	600-900 MHz	1700-2700 MHz	3500-4200 MHz	5000-6000 MHz
Peak Gain (Avg.)	7.1 dBi ± 1.2 dB	8.3 dBi ± 0.2 dB	8.4 dBi ± 0.3 dB	8.2 dBi ± 0.4 dB
Azimuth Beamwidth	105 ± 13 deg	78 ± 2 deg	58 ± 8 deg	50 ± 1 deg
Elevation Beamwidth	60 ± 3 deg	50 ± 2 deg	43 ± 8 deg	40 ± 1 deg
Front-to-Back Ratio (Avg.)	> 15 dB	> 22 dB	> 19 dB	> 20 dB
VSWR	≤ 2.1	≤ 1.5	≤ 1.3	≤ 2.1
Efficiency (Peak)	91 %	74 %	67 %	63 %
Input Imped.	50 Ω			
Polarization	Vertical			
Antenna Type	Directional			
Power Rating	50 W (Peak)			

Mechanical (Assembly):

Bolt Assembly	Bolt	Material	304 Stainless steel
		Spec.	M6 x 16 mm
	Flat Washer	Material	304 Stainless steel
		Spec.	M6
	Lock Washer	Material	304 Stainless steel
		Spec.	M6
	U-Bolt	Material	Q235 steel, Dacromet / Zinc-Aluminium flake coat
		Spec.	M6 x 94 mm
	Flat Washer	Material	304 Stainless steel
		Spec.	M6
U-Bolt Assembly	Lock Washer	Material	65Mn steel, Dacromet / Zinc-Aluminium flake coat
		Spec.	M6
	Nut	Material	Q235 steel, Dacromet / Zinc-Aluminium flake coat
		Spec.	M6
	Bracket	Material	Q235 steel, Dacromet / Zinc-Aluminium flake coat
L-Bracket		Material	Q235 steel, Dacromet / Zinc-Aluminium flake coated
		Dims. (l x h x w)	93.0 x 64.5 x 64.5 mm (3.7 x 2.5 x 2.5 mm)

Mechanical (Antenna):

Antenna Radome	Color	White
	Material	ABS (UV Stabilized)
	Dimensions (l x h x w)	443 x 210 x 65 mm (17.4 x 8.3 x 2.6 in)
Connector	Type	N-Female
	Type	RG58
Cable	Color	White
	Jacket Mat.	TPE
	Length	30 cm (1.0 ft)
	Bending Radius	50 mm (2.0 in) [Repeat] 25 mm (1.0 in) [Install]
	Net Wt.	1.1 kg (2.4 lbs)

Environmental:

Protection Class	IP65
Impact Rating	IK08
Rated Wind Velocity (Vert.)	160 kph (100 mph) [Sust.] 168 kph (105 mph) [Max]
Rated Wind Velocity (45°)	185 kph (115 mph) [Sust.] 200 kph (125 mph) [Max]
UV Rated?	Yes
Operating Temp.	-40 to +60 deg C (-40 to + 140 deg F)
Lightning Protect.	DC Ground



WAVEFORM

3411 W. Lake Center Drive,
Santa Ana, CA 92704

www.waveform.com
1-800-761-3041

Log Periodic Antenna

Directional High-Gain SISO Outdoor Log Periodic Antenna

Designed by WAVEFORM in the USA

600-900 MHz

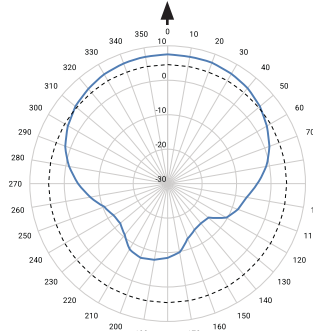

1700-2700 MHz

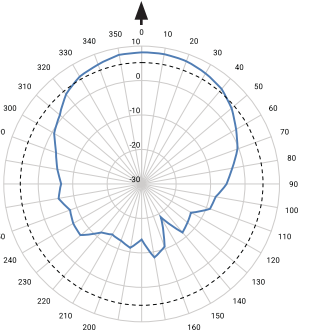

3500-4200 MHz

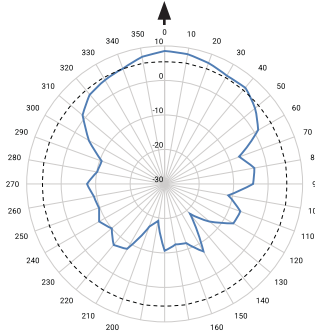

5000-6000 MHz

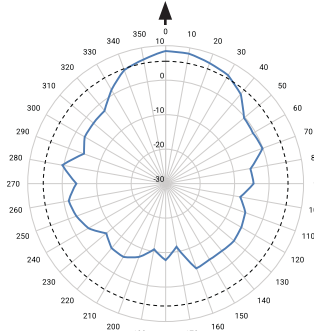

Azimuth Plane
"Top-down view"

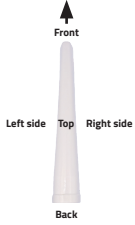

Elevation Plane
"Side-on view"

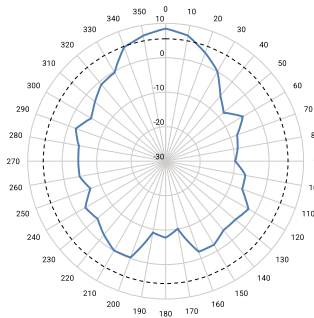
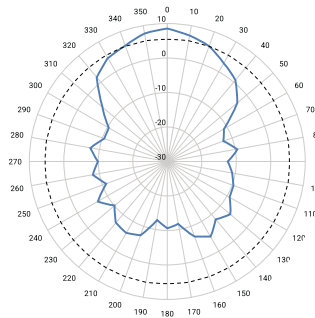
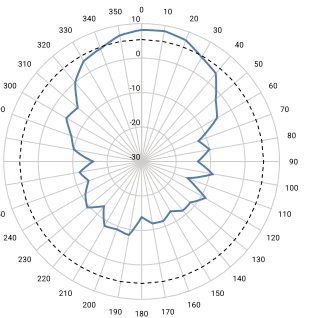
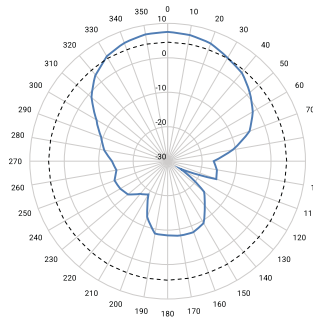

Antenna Peak Gain (dBi) by Frequency (MHz)

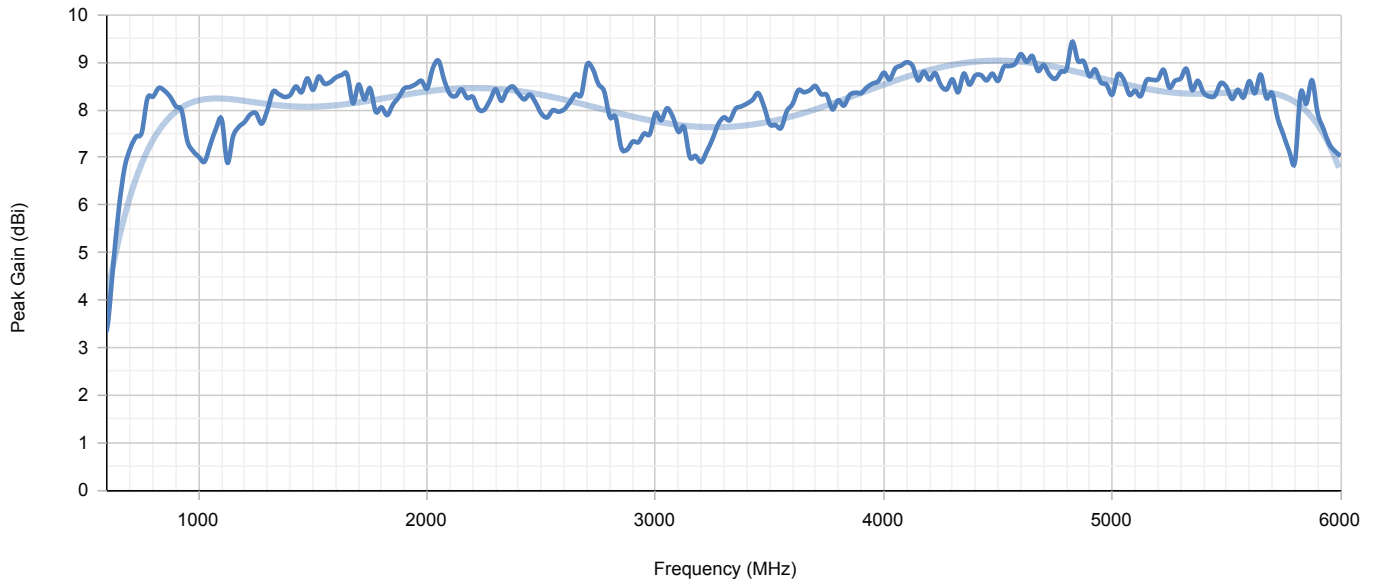

WAVEFORM

3411 W. Lake Center Drive,
Santa Ana, CA 92704

www.waveform.com
1-800-761-3041

Log Periodic Antenna

Directional High-Gain SISO Outdoor Log Periodic Antenna

Designed by WAVEFORM in the USA

Dimensions:

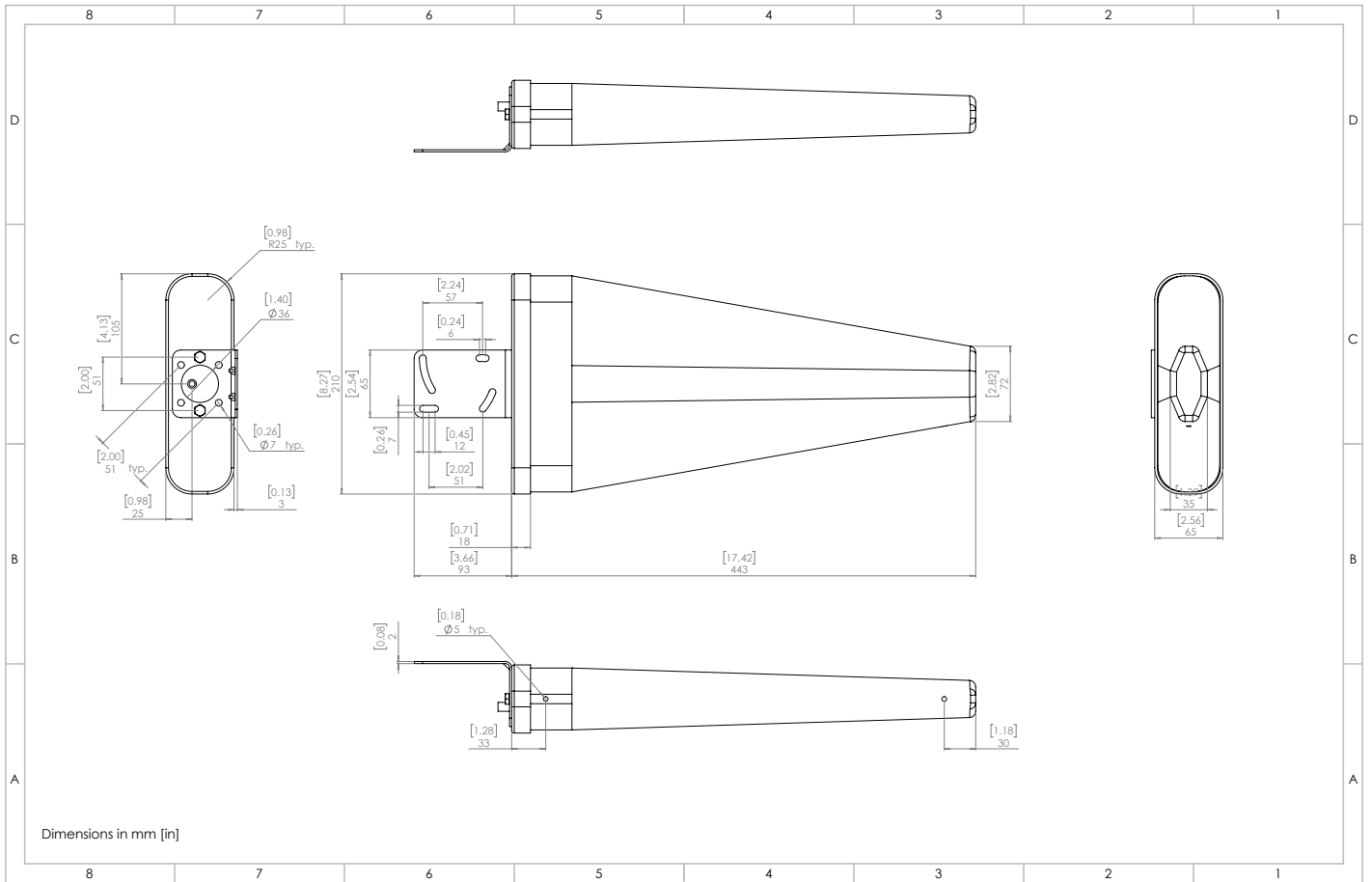

Griddy: Grid Parabolic Antenna

by WAVEFORM

SKU: ANT66NF-GP

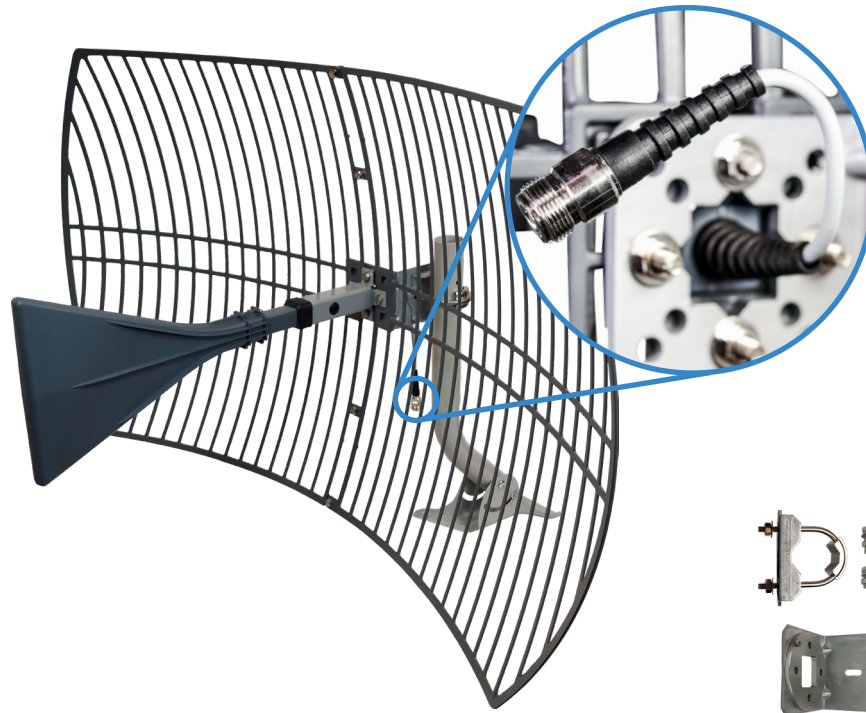

Main Features:

- Ultra Wideband Grid Parabolic Antenna
- 50 Ω
- 12-26 dBi
- 600-6500 MHz

Specifications:

Electrical:

Frequency Range	600-960 MHz	1700-2700 MHz	3000-6500 MHz
Gain	14.5 dBi \pm 2.5 dB	21.5 dBi \pm 1.5 dB	24.5 dBi \pm 1.5 dB
Horizontal Beamwidth	20 deg	12 deg	7 deg
Vertical Beamwidth	23 deg	15 deg	9 deg
Front-to-Back Ratio	20 dB		
VSWR	1.6:1	1.5:1	1.4:1
Input Impedance	50 Ω		
Polarization	Horizontal or Vertical		
Maximum Power	100 W		

Mechanical:

Type	Directional
Radome Color	Grey
Radome Material	ASA Anti UV
Dimensions	610 x 990 x 410 mm
Connector Type	N-Female
Cable Type	RG58
Cable Length	25 cm
Net Weight	2.4 kg
Mounting Type	Pole
Mounting Material	Aluminum
Mounting Mast Diam.	38-50 mm

Environmental:

Protection Class	IP65
Rated Wind Velocity	210 km/h
Operating Temperature	-0 to +60 deg C
Lightning Protection	DC Ground



WAVEFORM

3411 W. Lake Center Drive,
Santa Ana, CA 92704

www.waveform.com
1-800-761-3041

Griddy: Grid Parabolic Antenna

by WAVEFORM

600-960 MHz

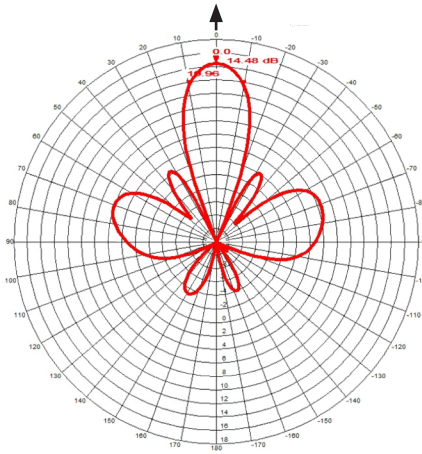

1710-2700 MHz

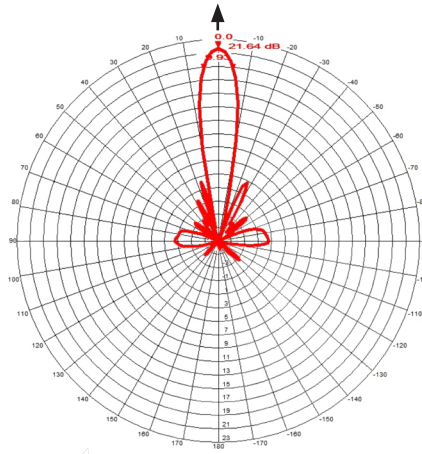

3000-6500 MHz

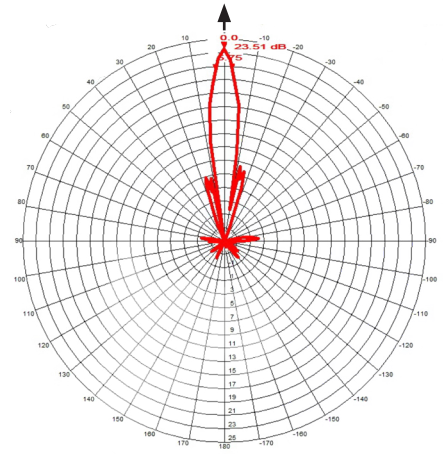

Vertical Plane
"Top-down view"



WAVEFORM

3411 W. Lake Center Drive,
Santa Ana, CA 92704

www.waveform.com
1-800-761-3041

Dome Antenna

by WAVEFORM

SKU: ANT627NF-DOME

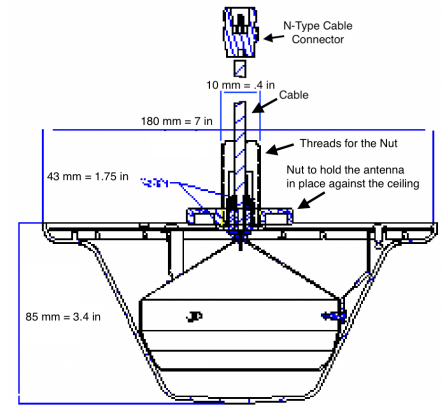

Main Features:

- Dome Antenna
- 50 Ω
- 3.0-5.5 dBi
- 600-6000 MHz

Specifications:

Electrical:

	600-960 MHz	1710-2700 MHz	2700-6000 MHz
Frequency Range	600-960 MHz	1710-2700 MHz	2700-6000 MHz
Gain (Peak)	2.5 dBi \pm 1 dB	5.5 dBi \pm 1.5 dB	5.0 dBi \pm 1 dB
Horizontal Beamwidth	360 deg		
Vertical Beamwidth	90 deg		
VSWR	\leq 1.7	\leq 1.5	\leq 1.5
Input Impedance	50 Ω		
Polarization	Vertical		
PIM (IM3)	\leq -140 dBm @ 33 dBm*2		
Maximum Power	50 W		

Mechanical:

Type	Omnidirectional
Radome Color	White
Radome Material	UV-Protected ABS
Dimensions	186 mm ϕ x 86 mm
Connector Type	N-Female
Cable Type	RG58
Cable Length	30 cm (12 inch)
Net Weight	275 g
Mounting Type	Ceiling
Mounting Material	ABS

Environmental:

Protection Class	IP52
Operating Temperature	-40 to +60 deg C
Limit Temperature	-55 to +70 deg C
Lightning Protection	DC Ground



WAVEFORM

3411 W. Lake Center Drive,
Santa Ana, CA 92704

www.waveform.com
1-800-761-3041

Dome Antenna

by WAVEFORM

650 MHz

1950 MHz

3800 MHz

5400 MHz

Vertical Plane
"Top-down view"

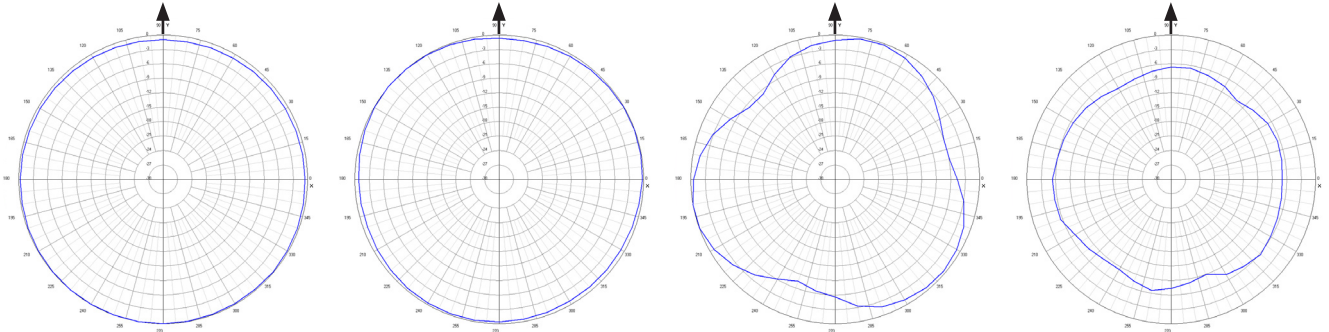

Horizontal Plane
"Side-on view"

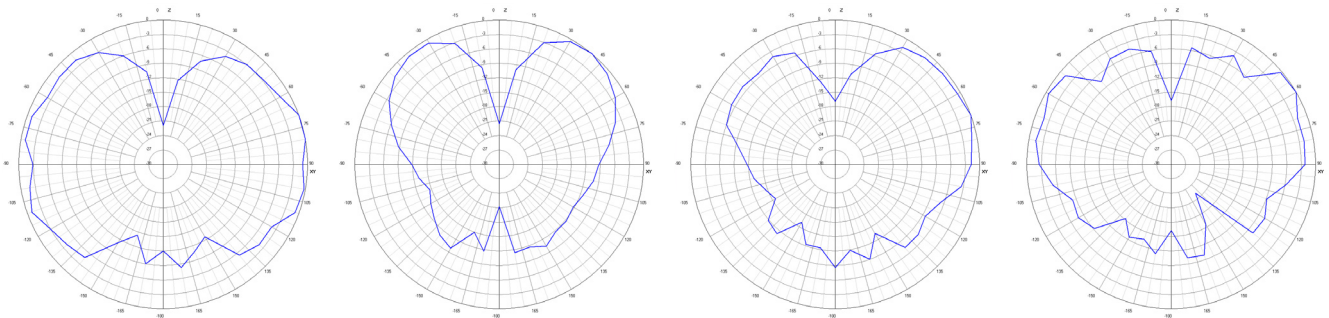

Antenna Peak Gain (dBi) by Frequency (Mhz)



WAVEFORM

3411 W. Lake Center Drive,
Santa Ana, CA 92704

www.waveform.com
1-800-761-3041

Panel Antenna

by WAVEFORM

SKU: ANT627NF-PANEL7

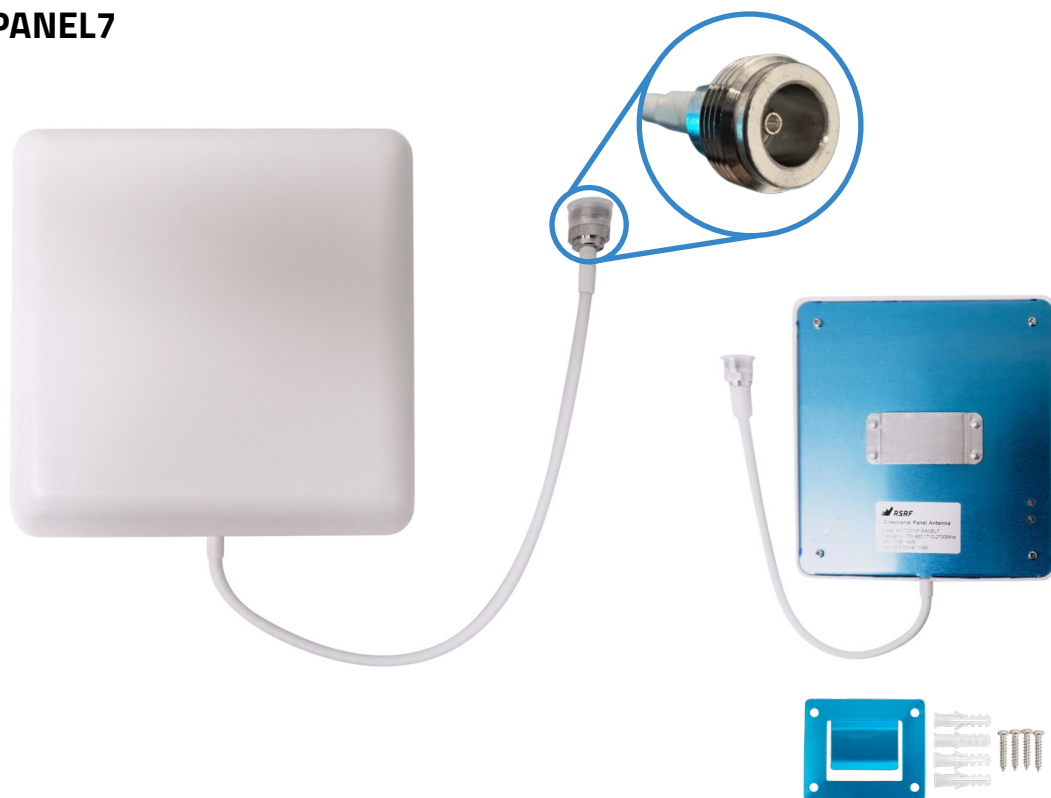

Main Features:

- Panel Antenna
- 50 Ω
- 7-8 dBi
- 600-6000 MHz

Specifications:

Electrical:

Frequency Range	600-960 MHz	1710-2700 MHz	2700-6000 MHz
Gain (Peak)	7 dBi \pm 1.0 dB	8 dBi \pm 1.0 dB	7.7 dBi \pm 1.5 dB
Horizontal Beamwidth	90 \pm 15 deg	75 \pm 12 deg	80 \pm 20 deg
Front-to-Back Ratio	\geq 6 dB	\geq 8 dB	\geq 10 dB
VSWR	\leq 1.4		
Input Impedance	50 Ω		
Polarization	Vertical		
PIM (IM3)	\leq -107 dBm @ 33 dBm*2		
Maximum Power	50 W		

Mechanical:

Type	Directional
Radome Color	White
Radome Material	ABS Plastic
Dimensions	210 x 180 x 44 mm
Connector Type	N-Female
Cable Type	RG58
Cable Length	30 cm (12 in.)
Net Weight	430 g
Mounting Type	Wall Mount
Mounting Material	Steel

Environmental:

Protection Class	IP52
Relative Humidity	5 to 95 %
Rated Wind Velocity	210 km/h
Operating Temperature	-40 to +70 deg C



WAVEFORM

3411 W. Lake Center Drive,
Santa Ana, CA 92704

www.waveform.com
1-800-761-3041

Panel Antenna

by WAVEFORM

650 MHz

1950 MHz

3800 MHz

5400 MHz

Vertical Plane
"Top-down view"
(normalized to peak gain)

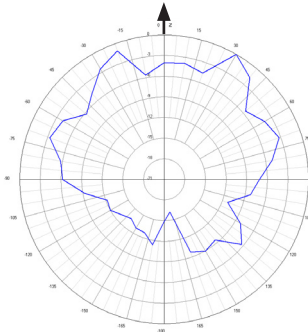
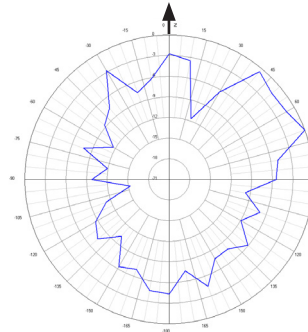
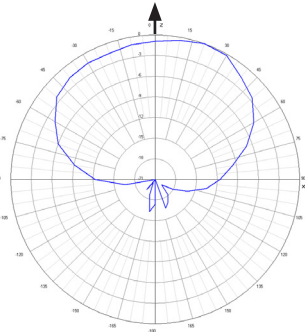
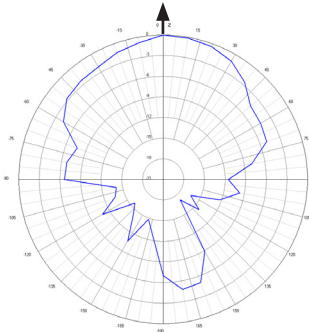

Horizontal Plane
"Head-on view"
(normalized to peak gain)

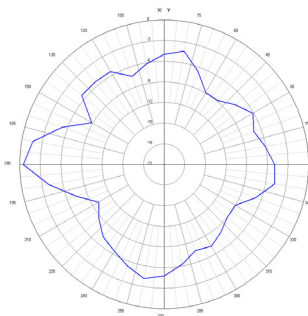
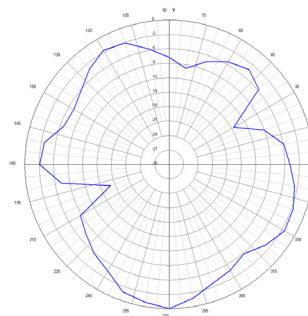
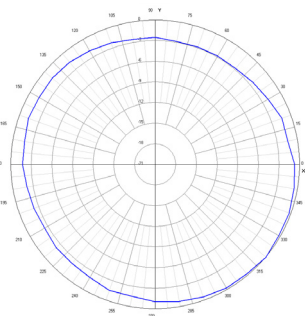
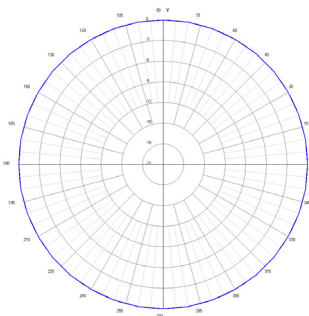

Antenna Broadside Gain (dBi) by Frequency (Mhz)

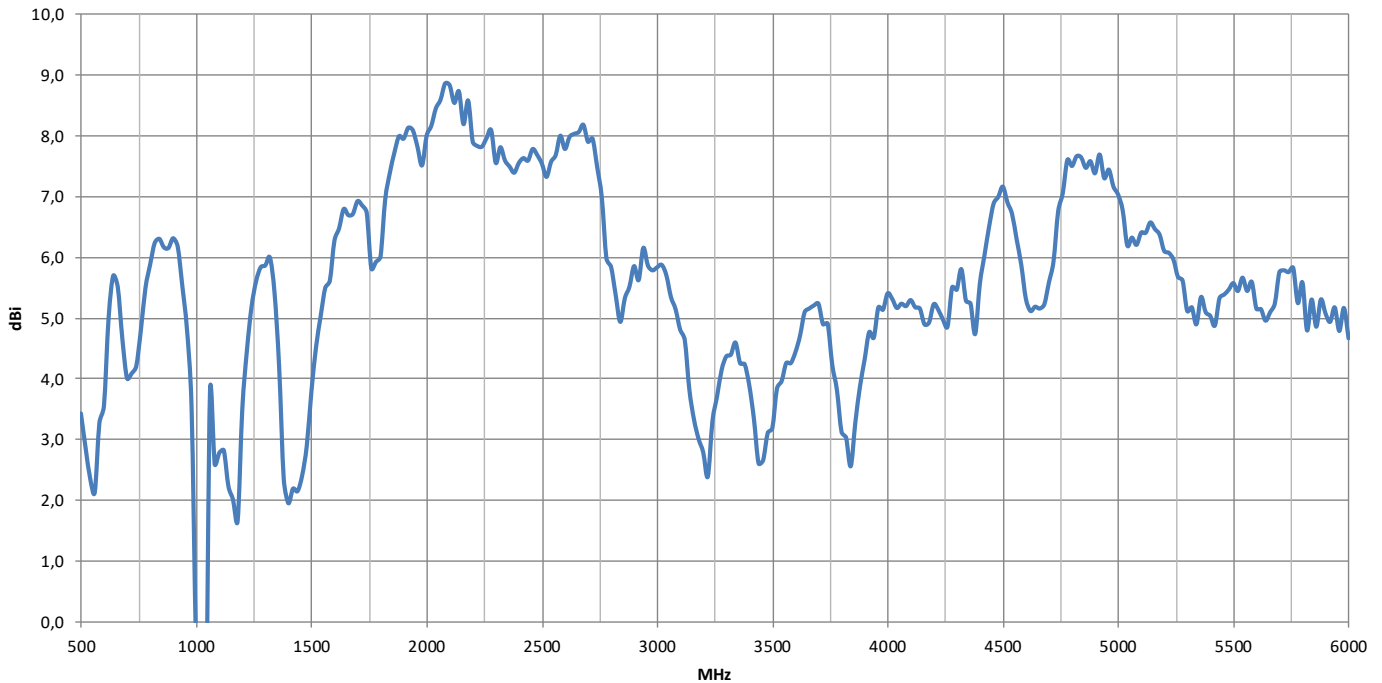

WAVEFORM

3411 W. Lake Center Drive,
Santa Ana, CA 92704

www.waveform.com
1-800-761-3041

UltraPole: The Universal Antenna Mount (Base Kit)

by WAVEFORM

SKU: WF-UPM-Base

Main Features:

- Made of galvanized carbon steel for corrosion protection
- 90° of free pivoting with 3 lockable pivot positions (0°, 45°, 90°)
- Integrated ground terminals
- Easy to install
- Net weight: 1.2 kg (2.7 lbs)



Specifications:

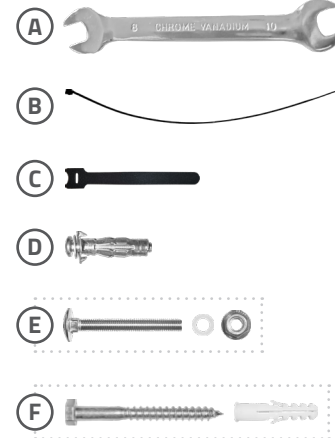
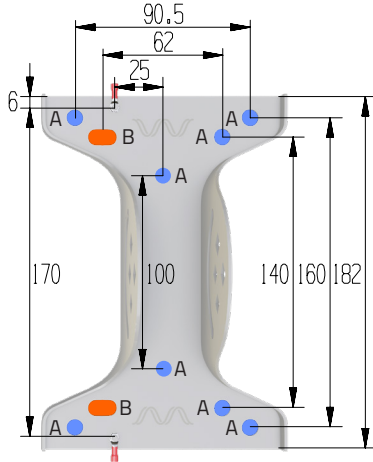
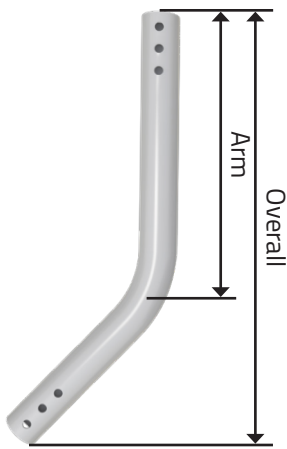

J-Pole:

Color	Industrial Grey (RAL7035)
Material	Galvanized Carbon Steel
Thickness	2.0 mm (0.1 in.)
Diameter	38 mm (1.5 in.) O.D. 34 mm (1.4 in.) I.D.
Overall Length	42.0 cm (16.5 inch)
Arm Length	26.7 cm (10.5 inch)
Coating	Matte Powder Coat
Weight	0.8 kg (1.8 lbs)
Quantity	1

Footpad:

Color	Industrial Grey (RAL7035)
Material	Galvanized Carbon Steel
Thickness	2.1 mm (0.1 in.)
Footpad	18.2 x 12.5 x 7.7 cm (7.2 x 4.9 x 3.0 in.)
Hole A	Ø8.3 mm (Ø0.33 in.)
Hole B	14.6 x 8.3 mm (0.6 x 0.3 in.)
Ground Terminal	M3 x 10.0 mm
Coating	Matte Powder Coat
Weight	0.4 kg (0.9 lbs)
Quantity	1

Mounting Tools:

#	Part Name	Material	Dimensions	Qua.
A	Wrench	Steel	Size-8/10 mm	1
B	Zip Tie	Plastic	250 mm	4
C	Velcro Tie	Plastic	150 x 12 x 1 mm	5
D	Expansion Bolt	Steel	M6 x 52 mm	5*
	Carriage Bolt	Steel	M6 x 55 mm	
E	Washer	Plastic	M6	4*
	Flange Nut	Steel	M6	
F	Hex-Head Wood Screw	Steel	M6 x 60 mm	5*
	Anchor	Plastic	Ø10 x 50 mm	

*Includes 1x spare

RS400 N-Male to N-Male Coaxial Cable

by WAVEFORM

SKU: RS400-x

Features:

- Variety of cable lengths available
- N-Male connectors
- 0 MHz to 6000 MHz
- 50 Ω Impedance
- 10.16 mm (0.4 in) diameter cable

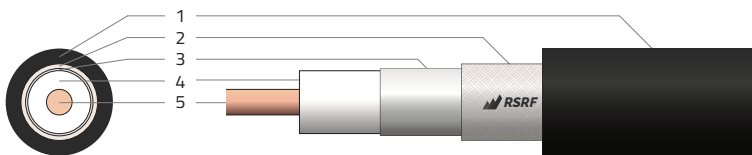

#	Description	Material	Diameter
1	Jacket	PE	10.16 mm (0.40 in)
2	Outer Shield	Tinned Copper Braid	8.10 mm (0.32 in)
3	Inner Shield	Bonded Aluminum Foil	8.09 mm (0.32 in)
4	Dielectric	PTFE	7.24 mm (0.29 in)
5	Inner Conductor	Copper Clad Aluminum	2.74 mm (0.11 in)

Specifications:

Electrical:

Input Impedance	50 Ω
Frequency Range	0 - 6000 MHz
VSWR	≤ 1.4
Capacitance	< 78.4 pF/m
Velocity	85 %
Shielding	> 90 dB
Power Rating (Peak)	16 kW

RF Attenuation (per 30 ft):

600 MHz	1.1 dB
900 MHz	1.4 dB
1800 MHz	2.1 dB
2100 MHz	2.3 dB
2500 MHz	2.5 dB
3000 MHz	2.8 dB
4000 MHz	3.2 dB
5000 MHz	3.7 dB
6000 MHz	4.1 dB

Mechanical:

Jacket Color	Black
Cable Diameter	10.16 mm (0.4 in)
Cable Length	Varying
Bending Radius	51 mm (2.0 in)
Connector Type	N-Male
Connector Diameter	20.3 mm (0.8 in)
Net Weight	0.08 kg/m (0.05 lbs/ft)

Environmental:

Burial Rated?	No
UV Rated?	Yes
Operating Temperature	-40 to +85 deg C (-40 to 185 deg F)



WAVEFORM

3411 W. Lake Center Drive,
Santa Ana, CA 92704

www.waveform.com
1-800-761-3041

RS200 N-Male Ultraflex Jumper Cables

by WAVEFORM

**SKUs: (1 ft), RS200-NM-NM-1
(3 ft), RS200-NM-NM-3
(5 ft), RS200-NM-NM-5**



Main Features:

- N-Male connectors
- 0-6000 MHz
- 50 Ω
- 4.95 mm diam. cabling

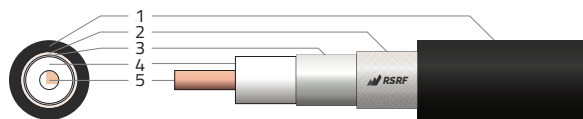

#	Description	Material	Diameter (mm)	Plating
1	Jacket	PE	4.95	N/A
2	Outer Shield	Copper Braid	3.66	N/A
3	Inner Shield	Aluminum Foil	3.07	N/A
4	Dielectric	PTFE	2.95	N/A
5	Inner Conductor	Copper	1.12	Gold
	N Body	Brass	20.3	Nickel
	Crimping Suite	Brass	N/A	Nickel
	Gasket	Silicon Rubber	N/A	N/A

Specifications:

Electrical:

Input Impedance	50 Ω
Frequency Range	0 - 6000 MHz
VSWR	≤ 1.2
Capacitance (pF/m)	< 80.4
Velocity	83 %
Shielding	> 90 dB
Power Rating (Peak)	2.5 kW

Environmental:

Protection Class	IP67
Burial Rated?	No
UV Rated?	Yes
Operating Temps.	-25 to +70 deg C

RF Attenuation (per 5 ft):

600 MHz	0.40 dB
900 MHz	0.50 dB
1800 MHz	0.71 dB
2100 MHz	0.77 dB
2500 MHz	0.84 dB
3000 MHz	0.93 dB
4000 MHz	1.08 dB
5000 MHz	1.22 dB
6000 MHz	1.34 dB

Mechanical:

Jacket Color	Black
Cable Type	RS200 (LMR200)
Cable Diameter	4.95 mm
	0.30 m (1 ft)
Cable Length	0.90 m (3 ft)
	1.50 m (5 ft)
Bending Radius	12.7 mm
Connector Type	N-Male
Connector Diameter	20.3 mm
	0.09 kg (for 1 ft)
Net Weight	0.11 kg (for 3 ft)
	0.15 kg (for 5 ft)
NFPA Rated?	No
ROHS Compliant?	Yes



WAVEFORM

3411 W. Lake Center Drive,
Santa Ana, CA 92704

www.waveform.com
1-800-761-3041

50 Ohm Lightning Surge Protector Kit

by WAVEFORM

SKU: WF-LSP-50-KIT

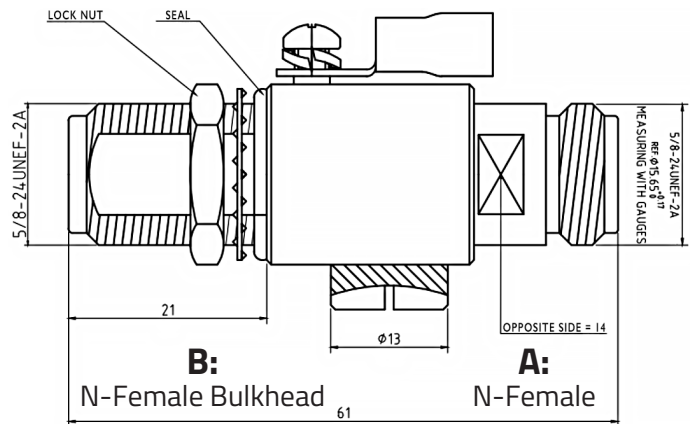

Main Features:

- N-Female to N-Female Bulkhead Surge Protector
- 0-6000 MHz Frequency Support
- 50 Ω Impedance
- 5 ft 10 AWG Grounding Wire
- 5 ft RS240 N-Male to N-Male Jumper Cable

Surge Protector Specifications:

Electrical:

Frequency Range	0 - 6000 MHz
VSWR (DC)	≤ 1.25
Insertion Loss	≤ 0.25 dB
Input Impedance	50 Ω
Insulation Resistance	≥ 5000 M Ω
Transmission Power	200 W
Gas Tube Breakdown Voltage (DC)	90 V
Withstanding Voltage (50 Hz, at sea level)	≥ 2500 V RMS
Working Voltage (50 Hz, at sea level)	≤ 1000 V RMS
Maximum Impulse Discharge Current (8/20 μ s)	20 KA 2000 J
Contact Resistance (Center Contact)	≤ 0.4 m Ω
Contact Resistance (Outer Contact)	≤ 0.2 m Ω

Mechanical:

Dimensions	22.7 mm \varnothing x 61.0 mm
Connector A Type	N-Female
Connector B Type	N-Female Bulkhead
Connector Body	Nickel Plated Brass
Body	Nickel Plated Brass
Pin Material	Gold Plated Brass
O-Ring Material	Rubber
Ground Connection	By Feedthrough or Screw Terminal
Net Weight	0.13 kg
NFPA Rated?	No
ROHS Compliant?	Yes

Environmental:

Protection Class	IP67
Operating Temperature	-55 to +155 deg C



WAVEFORM

3411 W. Lake Center Drive.,
Santa Ana, CA 92704

www.waveform.com
1-800-761-3041

N-Female Signal Splitter (2-Way, 3-Way, 4-Way)

by WAVEFORM

SKU: SPLT640NF-x

Main Features:

- 600-4000 MHz
- 50 Ω
- 300 W Power Handling

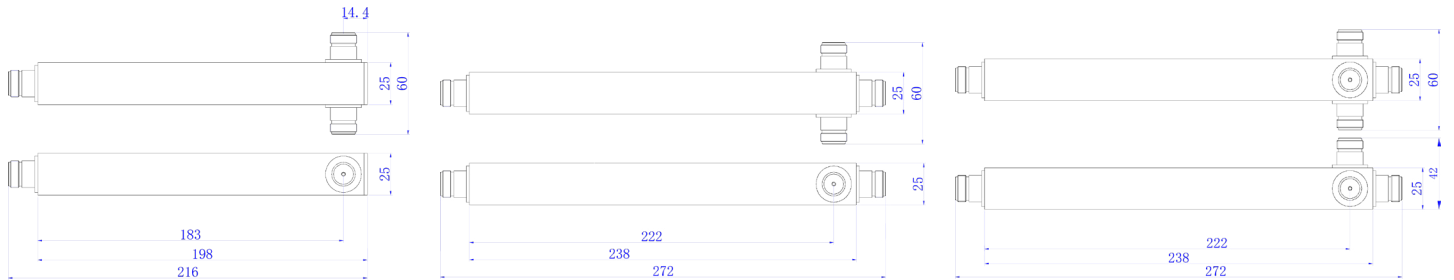

Specifications:

Electrical:

SKU	SPLT640NF-2	SPLT640NF-3	SPLT640NF-4
# of Splits	2-Way	3-Way	4-Way
Frequency Range	600-4000 MHz		
Input Impedance	50 Ω		
Insertion Loss (Typical)	≤ 0.3 dB		
Distribution Loss	3.0 dB	4.8 dB	6.0 dB
VSWR	≤ 1.25		
PIM (IM3)	≤ -154 dBc @ +43 dBm*2		
Power Rating (Average)	300 W		

Environmental:

Applied Environment	Indoor / Outdoor
Protection Class	IP65
Relative Humidity	5 to 95 %
Operating Temperature	-25 to +70 deg C

Mechanical:

SKU	SPLT640NF-2	SPLT640NF-3	SPLT640NF-4
Connector Type	N-Female		
Connector Material	Copper		
Cavity Color	Black		
Cavity Material	Silver Plated Aluminum		
Inner Conductor Material	Silver Plated Copper		
Dimensions	216 x 60 x 25 mm	272 x 60 x 25 mm	272 x 60 x 42 mm
Net Weight	0.34 kg	0.43 kg	0.48 kg



WAVEFORM

3411 W. Lake Center Drive,
Santa Ana, CA 92704

www.waveform.com
1-800-761-3041

SMA-Male to N-Female Pigtail Adapter

by WAVEFORM

SKU: PTA-SMAM-NF



Main Features:

- SMA-Male to N-Female connector
- 0-6000 MHz
- 50 Ω
- 4.95 mm diam. cabling

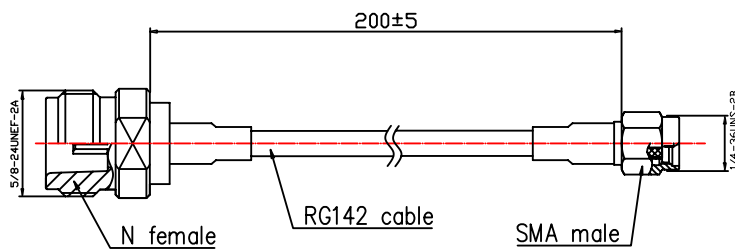

Section Description	Material	Plating
SMA Body	Brass	Gold/Nickel
N Body	Brass	Gold/Nickel
Crimping Suite	Copper Alloy	Nickel
Inner Conductor	Brass	Gold/Silver
Jacket	FEP	
Gasket	Silicone Rubber	
Dielectric	PTFE	

Specifications:

Electrical:		Mechanical:		Environmental:	
Input Impedance	50 Ω	Jacket Color	Tan	Burial Rated?	No
Frequency Range	600 - 6000 MHz	Cable Type	RG142	UV Rated?	No
VSWR	≤ 1.2	Cable Diameter	4.95 mm	Operating Temperature	-65 to +165 deg C
Capacitance	< 29.4 pF/m	Cable Length	20 cm		
Velocity	70 %	Bending Radius	25.4 mm		
Shielding	> 88 dB	Connector A Type	SMA-Male		
Power Rating (Peak)	5 kW	Connector A Angle	Straight		
Insertion Loss (Typical)	< 0.7 dB @ 6000 MHz	Connector A Diameter	7.9 mm		
		Connector B Type	N-Female		
		Connector B Angle	Straight		
		Connector B Diameter	15.7 mm		
		Net Weight	29 g		



WAVEFORM

3411 W. Lake Center Drive,
Santa Ana, CA 92704

www.waveform.com
1-800-761-3041